



Alpha Comfort 7 Day Wireless Programmable Room Thermostat

*Part No 3.022141 (Single Channel)
Part No 3.022142 (Two Channel)*

Installation and Users Instructions

1. Description

The Single Channel Alpha Comfort RF controller is a wireless programmable room thermostat capable of controlling time and temperature during heating on and off periods for InTec C, X and GS boilers.

The Two Channel Alpha Comfort RF controller has an additional channel for programming time period for hot water heating for InTec S model boilers.

2. Mounting of the Controller

The controller must be mounted in a position where it can not be influenced by direct sunlight, any device which might emit heat, near a door, window or be obstructed by curtains. It must be installed approximately 1.5m from the floor and any radiators within the same room must not have thermostatic radiator valves or any other thermostatic control fitted to them.

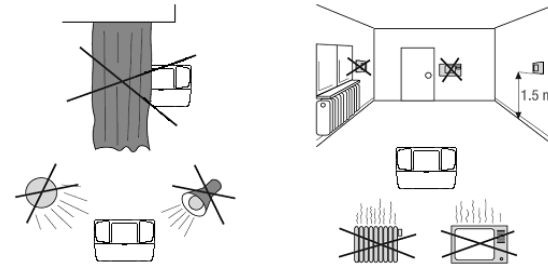

Fig 1

3. Fixing the Programmer to the Wall

Using a small screwdriver press down on the tab at the top of the controller (4) and separate the front control panel from the rear case.

Hold the rear casing in its chosen position level against the wall and mark the fixing holes.

Drill two 5mm holes in the wall, insert the wall plugs provided and fix the rear case to the wall using the 30mm screws.

Re-fit the front control panel, lower the control cover (1) and secure the control panel using the two 10mm screws provided (3).

Installing the Batteries

Using a small screw driver un-clip the bottom of the battery cover (2) and remove. Insert two Size AA batteries in the position shown in the back of the battery compartment and refit the battery cover.

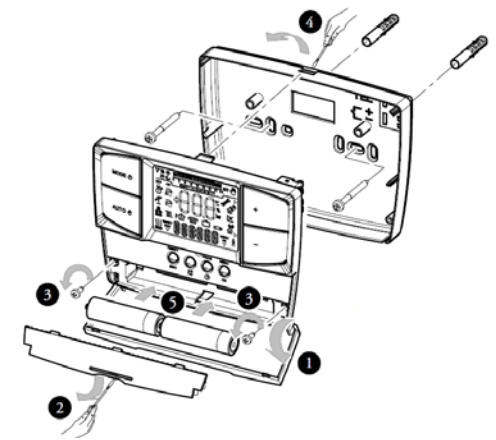

Fig 2

4. Installing the Boiler Receiver Unit (Fig 3)

Ensure the electrical supply to the boiler is isolated.

- a. Lower the front control cover and remove the two rubber stoppers to expose the control panel fixing screws. Remove the screws, raise the controls cover and lower the control panel.
- b. Remove the three screws securing the clock cover at the rear of the control panel and remove the cover. Fig 4.
- c. Push the clock blanking plate out of the control panel.
- d. Connect the boiler wiring to the receiver as follows:

Single Channel

Red wires to terminals 3 and 4
Brown wire to terminal 2
Blue wire to terminal 1

Two Channel

Brown to terminal 1
Blue to terminal 2
Black to terminal 3
Grey to terminal 4
White to terminal 5

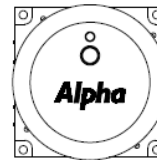

Fig 3

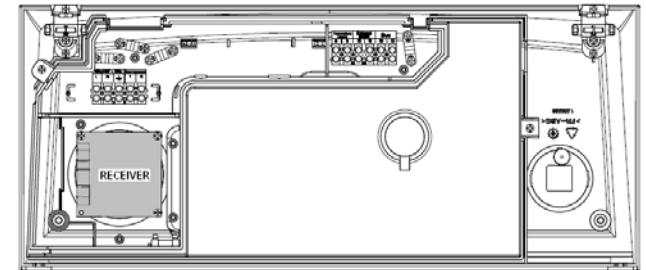

Fig 4

- e. Remove the receiver fixing screws from the control panel, insert the receiver and re-fit the screws.
- f. Replace the clock cover, raise and secure the control panel (two screws) and replace the rubber stoppers. Do not over tighten the screws.

5. Receiver LED Indicator

The receiver LED indicator informs the user of the current operating state of the boiler, the sequence of flashes and their definition are as follows:

Single Channel

One flash every six seconds – standby
One flash every second – communication lost (check batteries)
Two flashes every six seconds – central heating demand
Continuous flashing for ten seconds – awaiting signal during commissioning procedure

Two Channel

One flash every six seconds – standby
One flash every second – communication lost (check batteries)
Two flashes every six seconds – CH demand
One long flash and one short flash every six seconds – DHW demand
Three flashes every six seconds – DHW and CH demand
Continuous flashing for ten seconds – awaiting signal during commissioning procedure

6. Button Functions

Ref	Description
1	""Esc" return to previous menu
2	Comfort and economy room temperature setting button
3	Reset remote settings
4	Access button to time, day and timer
5	Access button to the programming/confirm parameters menu
6	Selector button: off, stand-by, summer and winter modes
7	Manual, automatic functioning button
8	Temperature decrease button
9	Temperature increase button

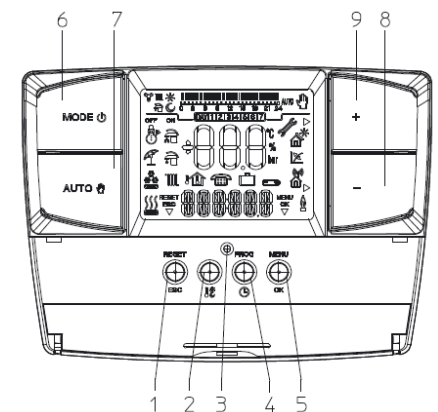

















Fig 5



Battery Warning Symbol

When the batteries in the transmitter are running low a battery symbol () will appear on the display. If the batteries go completely flat then the signal between the transmitter and the receiver will be lost and the receiver light will flash every second, this will cause the boiler to operate in its last command state. e.g. if the heating is on when the signal is lost then the heating will remain on until the batteries are replaced.

7. Display Symbol Descriptions

Symbol	Description	Symbol	Description
	Winter mode – DHW* and Central Heating enabled		Inside temp. display
	Summer Mode DHW enabled*		Remote phone activation
	Request for heating		Battery condition low
	Escape to previous screen		Holiday mode
	Cylinder heating in progress (if present)*		Indicates it is possible to adjust a parameter using buttons 11 and 12
	DHW Manually ON/OFF (flashing)* DHW Automatic ON (constant)*	000:000	Describes current status
	Displays room temp. and numerical data		Anomaly or Fault
	Functioning in wireless mode		

* 2CH Comfort models with System boiler an Cylinder

Symbol	Description
	Functioning with manual program
	Display of days of the week

Note; some icons can assume different meanings according to the context.

8. Programming

a. Set Time

Press the **PROG** button to enter the time setting mode, then press **OK** and the hour will flash. Using the +/- buttons adjust the time to the correct hour then press **OK**, the minutes will now flash, using the +/- buttons adjust the minutes then press **OK**. The day of the week will flash, using the +/- buttons set to the correct day of the week and press **OK** then **ESC** to get back to main menu.

b. Set Heating Programme

Press the **PROG** button and **TIME** will appear, press + and **CH PRG** will flash, press **OK** and **MONDAY** will appear. Using the + button you can programme individual days or blocks of days then press **OK**. On 1 will be displayed and the time will flash, using the +/- buttons you can select the time you wish the heating to turn on followed by **OK**, then using the +/- buttons you can set the time you wish the heating to turn off. Press **OK** and the next on period will appear, repeat the previous procedure for the next on-off periods for the rest of the day to a maximum of four on periods. After one minute the display will return to main menu or keep pressing **ESC**.
NOTE: if four on off periods are not required then set the unused periods on off times the same.
 E.g. On 23:00 off 23:00.

c.(1) Set Hot Water Programme

Note; The hot water programmes only need to be set when a hot water storage cylinder is present.

Press the **PROG**  button and TIME will appear, press + twice and HW PRG will flash, press **OK** twice and MONDAY will appear. Using the + button you can programme individual days or blocks of days then press **OK**. On 1 will flash on the display with a time below it, using the +/- buttons you can select the time you wish the hot water to turn on followed by **OK**, then using the +/- buttons you can set the time you wish the hot water to turn off. Press **OK** and the next on period will appear, repeat the previous procedure for the next on-off periods for the rest of the day to a maximum of four on periods. After one minute the display will return to main menu or keep pressing **ESC**.

NOTE: if four on off periods are not required then set the unused periods on off times the same.
E.g. On 23:00 off 23:00.

c.(2) Set Hot Water Override 2Ch Models Only

The hot DHW programme can be overridden manually to set the DHW continuously ON or OFF;

Press the **PROG**  button and TIME will appear, press the + button twice and the HW PRG will flash, press **OK**. Using the + button to scroll through the following options;

 symbol = DHW demand is continuously ON, press **OK** to confirm.



 symbol = DHW function if held OFF, press **OK** to confirm.



A further press of the + button and the programme function will appear, press **OK** to confirm.

After one minute the unit to return to main screen or Press **ESC**.

d. Setting the Temperature

Note; There are two temperature settings, comfort which is the heating on setting and economy which is the heating off setting. The comfort temperature is the room temperature required during the heating on period. The economy temperature is the minimum allowable room temperature, e.g. if the economy temperature is set to 10°C and the temperature drops below this during a heating off period the boiler will switch on to maintain the 10°C setting.

Press the  button and the word COMFOR will appear with the temperature flashing above and a  symbol. Using the +/- buttons set the temperature as required then press **OK** to store.

Press the  button twice and the word ECONOM will appear with the temperature flashing above and a  symbol. Using the +/- buttons set the temperature as required then press **OK** to store.

9. a. Mode Selection

By pressing the Mode Selection button you can scroll through the following settings;

Off: Controller off.



Stand by: Heating off but room frost protection active. The room temperature is displayed.

Winter  : Timed heating on.



For 2Ch models

Summer  : Only DHW functions are enabled with frost protection function active.

b. Continuous Override

The override function is used to manually control the boiler, press the **AUTO**  button and use the +/- buttons to set the desired room temperature. To turn off the manual override press the **AUTO**  button.

c. Temporary Override

To access Temporary override press the +/- buttons to set the desired temperature and the  symbol will flash in the top right hand corner of the display. The room temperature will be maintained until the next timed on or off period or press the **AUTO**  button to come out of temporary override.

d. Room Frost Protection

If the temperature in the room where the programmer is installed drops to 5°C the boiler will operate at minimum heating output until the room temperature has been raised to 5.6°C.

e. Faults Diagnostics and Errors

Code	Description
ERR>TP	Error in reading the room temperature or value measured off scale (below 0°C or over 50°C)

f. Diagnostics

Comfort RF Boiler Communication

The communication between the remote and the boiler mounted receiver is identified with the symbol. 

There are three possible conditions shown via this symbol:

1. Symbol not present - No compatible connection between devices.
2. Symbol flashing - Connection with communication error
3. Symbol permanent - Communication OK

g. Reset Comfort remote control

By pressing the reset button (ref 3 fig 5) the Comfort remote control hardware can be reset without losing the user setting, such as time, date and timed programmes.

If the Comfort remote control original factory settings are to be restored it can be done as follows.
Press and release the button in the reset hole (ref 3 fig 5) holding the **RESET** button down (ref 1 fig 5).
This will restore the factory set data, keeping current time and day.

h. Special functions

By pressing the **MENU** button, a list of options can be accessed, by pressing the +/- buttons you can scroll through the various options and to select press **OK**.

i. Language

Allows the user to choose between Italian and English.

j. **Regult (management of regulation parameters)** (This function is not activated)

k. **Holiday Mode**

During winter mode function it is possible to deactivate both the hot water and central heating for a defined number of days (1 to 99). When the set number of days has past normal function will resume.

When the holiday mode is set a flashing  will be displayed and the number of days it is enabled for.

To set the holiday mode press **OK** then the + button until HOLIDY appears then **OK** to accept. **Off** will be displayed and by pressing the + button the number of days can be set, press **OK** then **ESC** to get to main menu and the  symbol and set number of days will flash at the bottom of the screen.

This function can be deactivated by pressing the **AUTO**  button.

In the event of remote telephone activation the Comfort controller will revert back to normal operation omitting the holiday program.

NOTE; the frost protection function is still active during holiday mode.

10. Commissioning Procedure

The comfort timer is pre-commissioned (paired to the receiver). Should the timer need to be match to a new receiver then commissioning must be carried out as follows;

a. access the code menu and enter the code 9977.

b. the **Test-RF** menu will appear (**RF>CHK**).

c. Press the **OK** button and the **RF>INS** commissioning instruction menu will appear if they are not already linked, otherwise the **RF>REM** de-commissioning menu will appear.

d. Within 30 seconds press and hold the small black button on the receiver for 5 seconds until the LED flashes.

e. By pressing the **OK** button on the comfort timer the signal transmission will be sent to the receiver and **RF>>>>** will show on the screen.

f. **RF>REM** and a  symbol will appear once the controller and receiver have paired.

g. Wait for 30 seconds for the screen to revert back to its normal display and the Comfort timer is ready to use.

11. Technical Characteristics

a. Receiver Data:

- Base Power Supply:.....240V nominal AC Control Panel Connection
- RF communication:.....backbone 868 MHz, GFSK modulation, cover 30-100 m (depending on the environment)
- Power and duty cycle:.....Power Tx < 10 dBm, duty cycle < 0.1%in one hour (in normal functioning mode)
- Dimensions (LxHxD):.....61.9 x 61.9 x 31.7
- Protection rating according to EN 60730:.....II*
- Protection rating according to EN 60529:.....IP 30*

*= only when installed on the boiler

b. Controller Data:

- Dimensions (LxHxD):.....142 x 103 x 31
- Power Supply:.....2 x 1.5 V, AA batteries
- Functioning room temperature:.....0 - +40°C
- Warehouse temperature:.....-10 - +50°C
- Protection rating according to EN 60730:.....II
- Protection rating according to EN 60529:.....IP 20
- Precision indication room temp.:.....+/- 0.5°C a 25°C*
- NTC room temp. sensor:.....50 k at 25°C
- Clock indication diversion:.....+/- 15 minutes/year

* = the indication of the room temperature can be affected by the point of installation of the Alpha Comfort remote control (e.g. hot wall, cold wall, height from the ground, etc.)

c. Factory Settings

- Central Heating Comfort Temperature 20.0 °C
- Central Heating Economy Temperature 16.0 °C
- Room Temperature in Manual 20 °C
- Anti Freeze 5.0 °C
- Holiday Program..... HOLIDY = OFF
- Building Inertia BUILD = 10
- Room Probe..... AMB = ON
- Reading Correction AMB CR = 0.0 °C
- Telephone Control REMOTE = ON
- Modulation MODUL = OFF
- Hysteresis..... HYSTER = 0.3°C
- Modulation MODUL = OFF

Alpha
HEATING INNOVATION

Alpha Therm Limited.
Nepicar House, London Road, Wrotham Heath,
Sevenoaks, Kent TN15 7RS
Tel: 0844 871 8764
Email: info@alpha-innovation.co.uk
Website: www.alpha-innovation.co.uk

These instructions have been carefully prepared but we reserve the right to alter the specification at any time in the interest of product improvement.
© Alpha Therm Limited 2011.

Doc No 1.031210 Rev 15.035776/000